



CK series

Mid-Priced CMOS IC Time Delay Relay

- Choice of timing modes
 - Delay on operate
 - Delay on release
 - Delay on dropout (no input required during timing)
 - Interval on
- Knob or resistor adjustable types
- 10A output relay with DPDT contacts
- Various models time from 0.1 to 180 sec.

File E22575

File LR15734

Users should thoroughly review the technical data before selecting a product part number. It is recommended that user also seek out the pertinent approvals files of the agencies/laboratories and review them to ensure the product meets the requirements for a given application.

Timing Modes

Delay on operate – Delay period begins when input voltage is applied. At the end of the delay period, the relay will operate and will not release until input voltage is removed. Reset occurs when input voltage is reapplied.



Delay on release – Input voltage must be applied continuously to operate the internal relay. When the control switch is closed, the relay energizes. When the control switch is opened, timing begins. When timing is complete, the relay will de-energize. Time may be reset to zero during timing by closing the control switch.

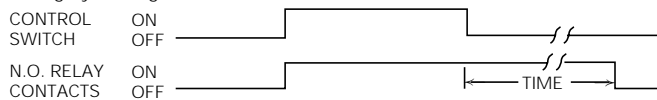

Delay on dropout – The relay operates immediately upon application of input voltage. Timing begins when input voltage is removed. When timing is complete, the relay will de-energize. Reset occurs when input voltage is reapplied.

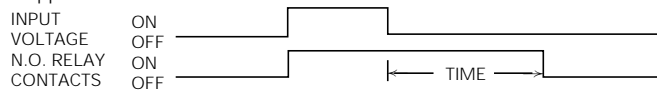

Interval on (with control switch) – Input voltage must be applied continuously to operate the internal relay. The relay energizes and timing begins when the external switch is closed. At the end of the time delay period the relay will de-energize. Reset is accomplished by opening and reclosing the control switch.



Timing Specifications

Timing Ranges: From 0.1 to 180 sec.

Timing Adjustment: External resistor and knob adjustable.

Tolerance (for AC units add $\pm 1/2$ cycle 60 Hz.):

Knob Adj. Types: -0, +20% of max. specified at high end of timing range; min. specified, or less, at low end.

Fixed Types: $\pm 5\%$.

Res. Adj. Types: $\pm 5\%$ at high end of timing range; min. specified, or less, at low end.

Delta Time (for AC units add ± 1 cycle 60 Hz.): $\pm 10\%$.

Repeatability (for AC units add ± 1 cycle 60 Hz.): $\pm 2\%$.

Release Time: 60 ms, typ.; 100 ms, max.

Recycle Time: 60 ms, typ.; 100 ms, max.

Contact Data @ 25°C

Arrangements: 2 Form C (DPDT).

Material: Silver-cadmium oxide alloy.

Rating: 10A @ 30VDC or 277VAC, resistive; 1/2 HP @ 250VAC; 1/3 HP @ 120VAC.

Expected Mechanical Life: 10 million operations.

Expected Electrical Life: 100,000 operations, min., at rated load.

Initial Dielectric Strength

Between Open Contacts: 500V rms, 60 Hz.

Between All Other Conductors: 500V rms, 60 Hz.

Input Data @ 25°C

Voltage: 24 & 120VAC and 12 & 24VDC.

Power Requirement: AC Types: Typically less than 3 VA.

DC Types: Typically less than 3 W.

Initiate Time: Delay on dropout timers must have input voltage applied for a minimum of three seconds for dropout function to be guaranteed.

Transient Protection: Yes.

Reverse Voltage Protection: Yes.

Input Voltages & Limits @ 25°C

Voltage Type	Nominal Voltage	Minimum Voltage	Maximum Voltage
AC	24 120	20 105	28 130
DC	12 24	11 20	13 32

Note: DC voltage must be filtered (5% p-p ripple max. at nom. voltage).
AC models will operate on 50 or 60 Hz.

Environmental Data

Temperature Range: Storage: -55°C to +85°C.

Operating: -10°C to +55°C.

Mechanical Data

Termination: 8- or 11-pin octal style plug.

Enclosure: White plastic case. Knob adjustable types have dial scale for reference only.

Sockets: Models with 8-pin base fit either 27E122 or 27E891 (snap-on) screw terminal sockets. 11-pin types fit either 27E123 or 27E892 (snap-on) screw terminal sockets.

Weight: 6 oz. (170g) approximately.

Ordering Information – Authorized distributors are more likely to stock boldface items listed below.

Delay On Operate Models

Voltage	Time	Adjustment	Wiring Dia.	Part Number
24VAC	0.1 to 10 Sec.	Knob	1	CKB-38-30010
120VAC	0.1 to 10 Sec.	Knob	1	CKB-38-70010
	0.6 to 60 Sec.			CKB-38-70060
	1.2 to 120 Sec.			CKB-38-70120
120VAC	1.8 to 180 Sec.			CKB-38-70180
120VAC	0.1 to 10 Sec.	Resistor	2	CKF-38-70010
12VDC	0.1 to 10 Sec.	Knob	1	CKD-38-20010

Delay On Release Models

Voltage	Time	Adjustment	Wiring Dia.	Part Number
120VAC	0.1 to 10 Sec.	Knob	3	CKB-38-78010
	0.6 to 60 Sec.			CKB-38-78060
	1.8 to 180 Sec.			CKB-38-78180
120VAC	0.1 to 10 Sec.	Resistor	4	CKF-38-78010
24VDC	0.1 to 10 Sec.	Resistor	4	CKH-38-38010

Delay On Dropout Models

Voltage	Time	Adjustment	Wiring Dia.	Part Number
24VAC	0.1 to 10 Sec.	Knob	1	CKB-38-37010
	0.6 to 60 Sec.			CKB-38-37060
120VAC	0.1 to 10 Sec.	Knob	1	CKB-38-77010
	0.6 to 60 Sec.			CKB-38-77060
	1.2 to 120 Sec.			CKB-38-77120

Interval On Models

Voltage	Time	Adjustment	Wiring Dia.	Part Number
120VAC	0.1 to 10 Sec.	Knob	3	CKB-38-79010

Outline Dimensions

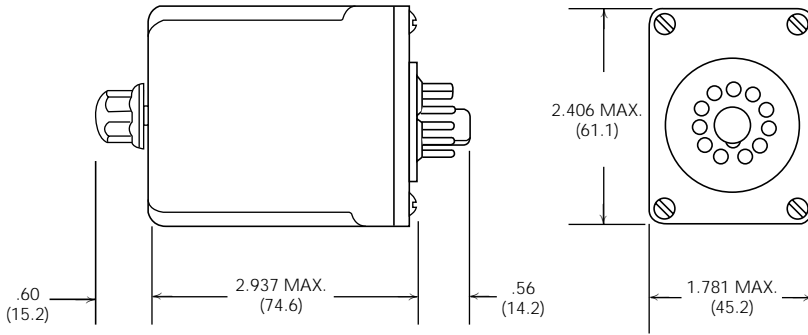

Wiring Diagrams – Bottom Views (pins numbered clockwise from keyway)



* If control switch is closed when power is applied, relay will immediately energize. A 50 millisecond minimum switch closure is required. IMPORTANT: A dry circuit switch is recommended. A * dry circuit* switch is one rated to reliably switch currents of less than 50mA. Use of a switch rated for other than dry circuit may result in failure of the time delay relay to function properly.
 ** Note: Input polarity for DC operation. For most reliable operation on AC, connect high side to "+" and low side to "-".

External Resistor Chart

See External Resistor Selection Charts at beginning of Time Delay Relay section of this Databook.